



MODEL NUMBER: XRH900-1-0-GB-XX

IMPROX REGISTRATION INTERFACE

ImproX (RH) Registration Interface INSTALLATION MANUAL

SPECIFICATIONS

Working Environment	The ImproX RH is designed to work in an indoor (dry) environment similar to IP20. The ImproX RH is, therefore, NOT sealed against water.	
Scanner Operation	125 kHz and 13.56 MHz (ImproX Mifare Remotes).	
Input Voltage	10 V DC to 30 V DC.	
Power Requirements	Current (mA)	Power (W)
Input Voltage 10 V DC	100	1.0
Third-party Port	5 V DC \pm 0.1 V is supplied to power the single Reader connected to this Port. A maximum of 100 mA can be supplied from this Port.	
Installer Interfaces		
LED Indicators		
Power LED	Blue (steady) (externally visible).	
USB Tx LED	Red (flashing) (internally visible).	
USB Rx LED.....	Green (flashing) (internally visible).	
RS485 Tx LED.....	Red (flashing) (internally visible).	
RS485 Rx LED	Green (flashing) (internally visible).	
ImproX RRA or RRM		
Status Indicator		
Status LED.....	Bi-colour, Red or Green LED.	
Buzzer		
Volume and Tone	Four volume, single tone (Software dependent).	

INSTALLATION INFORMATION

Accessories

Find the following when unpacking the Registration Interface:

- An ImproX (RH) Registration Interface housed in a Black, Aluminium extruded Cabinet. The Cabinet consists of a Top Cover, a Base and two End Plates (each End Plate is attached with three Thread Cutter Screws (M3 x 8 mm)).
- Four Brass Wood Screws (3.5 mm x 25 mm).
- Four Wall Plugs (7 mm).
- A 1.8 m (5.90 ft) standard USB Cable with a Type A to Type B Connector.
- An extra Fixed Address Label.

General

Remember the following when installing the Registration Interface:

FCC Compliance

For FCC compliance:

- Ensure the comms cable is routed through a separate grommet to the power cable.
- Ensure that you use a CE approved Power Supply Unit.

Communications Distance

- The USB communications distance between the Host PC and the Registration Interface MUST NOT exceed 5 m (16.40 ft).
- DO NOT cut and join the supplied USB Cable. If extension of the USB Cable is required, source a new longer length USB Cable.

Distance between the Registration Interface and the ImproX RRM or ImproX RRA

The maximum cable distance between the ImproX Registration Interface and the ImproX RRM or ImproX RRA, MUST NOT exceed 2 m (6.56 ft).

Distance between ImproX RRAs or ImproX RRM's from DIFFERENT Registration Interfaces

To avoid mutual interference install the ImproX RRAs or ImproX RRM's no closer than 500 mm (20 in) apart.

Mounting the Cabinet

CAUTION: Make certain that you mount the ImproX RH on a vibration-free surface.

Select the mounting position of the ImproX RH, considering accessibility, routing of wires and visibility of the externally visible Power LED.

Secure the Cabinet to the mounting surface, using four suitable screws and wall plugs (supplied), nuts and bolts or rivets.

DIP-switch Settings

The format selection for each type of device that can be connected to the Third-party Port is made by setting the internal DIP-switches as indicated in Table 1.

NOTE: Terminals 'A' and 'B' in Table 1 are on the Third-party Port Terminal Block.

DIP-switch Position	Format	Connections
0  DIP-switch 0 shows all the switches in the OFF position	No peripheral Reader	N/A
1  DIP-switch 1 shows switches 2, 3 and 4 in the OFF position	Mifare Remote (ImproX RRM)	Rx to terminal 'A' Tx to terminal 'B'
2 	RF Receiver	Data Line to terminal 'B'
3 	Magstripe ABA Track 2	Data Line to terminal 'A' Clock Line to terminal 'B'
4 	Barcode Code-39 with Checksum	Data Line to terminal 'B'
5 	Barcode Code-39 without Checksum	Data Line to terminal 'B'
6 	Wiegand 26/37/40 and 44	0 Data Line to terminal 'B' 1 Data Line to terminal 'A'
7 	Wiegand Open Format	0 Data Line to terminal 'B' 1 Data Line to terminal 'A'

Table 1: DIP-switch Settings

NOTE: Once the DIP-switch setting is modified reset the ImproX RH to acknowledge the new settings.

Blank Space

CONNECTING THE REGISTRATION INTERFACE

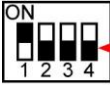
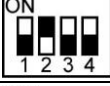
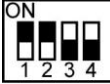
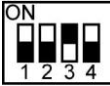
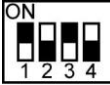
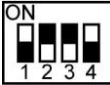
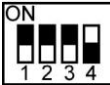
Figure 1 shows a detailed connection diagram for the ImproX RH.

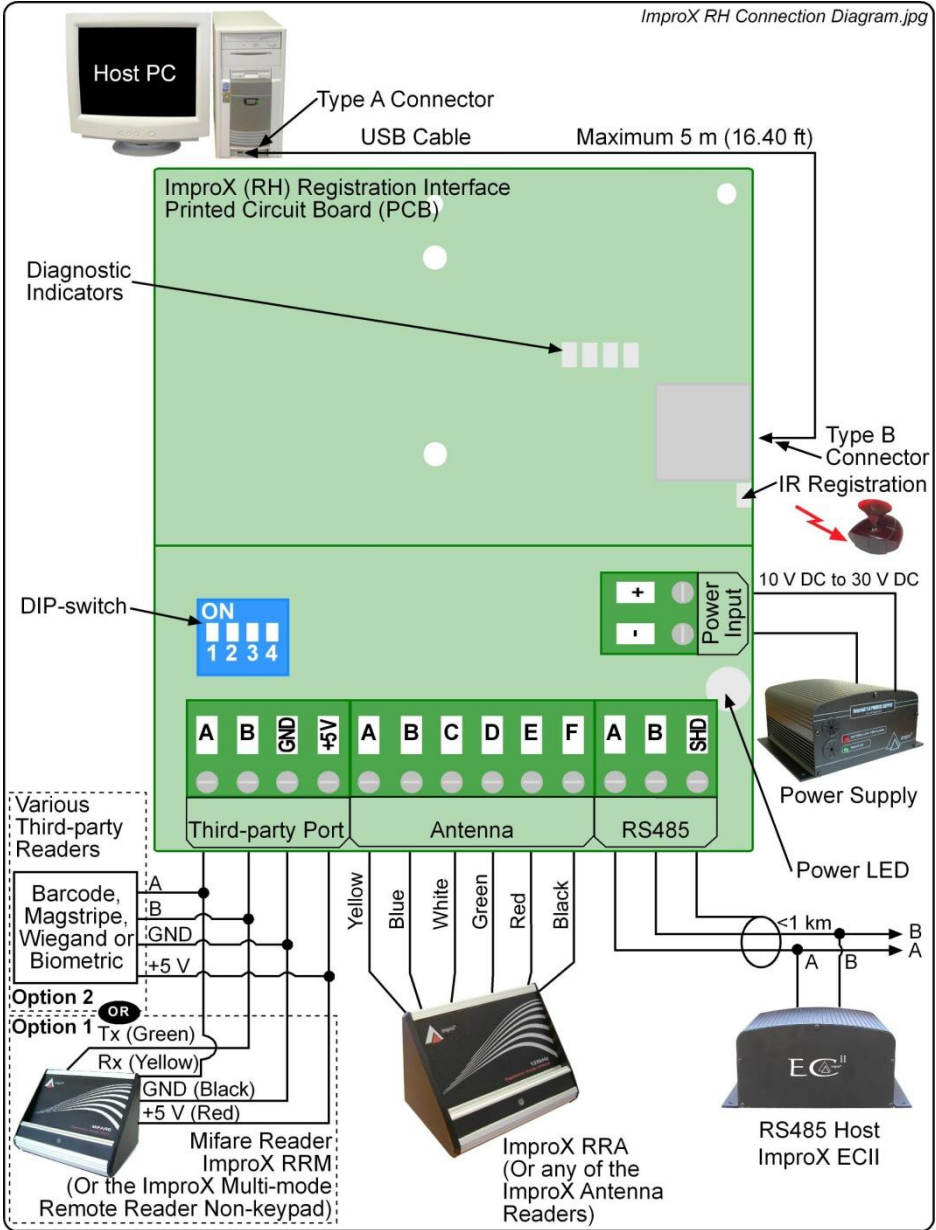

Figure 1: Typical ImproX RH Electrical Connections

Power-on Self-test

The Power-on Self-test tests the RAM and Flash Checksums.

If any parameter in the Self-test fails, the Registration Reader (i.e. ImproX RRA or ImproX RRM) emits a continuous beep for 2 seconds.

When the Registration Interface passes the Self-test, the Registration Reader (i.e. ImproX RRA or ImproX RRM) emits two short beeps, each 200 ms in duration, separated by a 200 ms inter-beep pause.

Testing the Connection

When the Registration Interface is connected, check that the Power LED is illuminated Blue (steady). This will confirm that the connection is correct and working.

Fixed Address Label

Keep the Fixed Address Label in a safe place, as you may need the Label at a later date if you wish to upgrade your Software.

GUARANTEE OR WARRANTY

This product conforms to our Guarantee or Warranty details placed on our Web Site, to read further please go to www.impro.net.

USER NOTES

USER NOTES

USER NOTES



This manual is applicable to the ImproX (RH) Registration Interface,
XRH900-1-0-GB-01.

(The last two digits of the Impro stock code indicate the issue status of the product).

XRH300-0-0-GB-07	Issue 08	Feb 2009	ImproX RH\English Manuals\LATEST ISSUE\ ImprX RH-inism-en-08.docx
------------------	----------	----------	--